



# ROTARY & FLAIL MOWER TECHNOLOGY

Quality, innovation and productivity  
World-class mowing solutions

# SPECIALISTS IN VEGETATION MAINTENANCE

McConel is proud to offer a comprehensive range of precision-engineered flail and rotary mowers that excel everywhere from the golf course to the stubble field and are renowned across the world for quality, value and productivity.

“

I love the SR620. It's fast and effective and ideal for mowing contractors because you can cover a huge area in a very short time."

James Tibbetts,  
Essex Plant Hire specialist





## WORLD-LEADER IN GREEN-MAINTENANCE TECHNOLOGY

A multi award-winning British manufacturing company with a successful 80-year heritage, McConnell has been at the forefront of green maintenance since launching its first mower back in 1953.

The company's success has been built on continually delivering breakthroughs in technology that boost performance and productivity and in offering machines for almost every task and work environment.

So whether you're after a compact 1.3m flail mower that's ideal for amenity work, a 2.0m heavy-duty mulcher for clearing shrubland, or an 8.2m flex-wing mower for the best in productivity – McConnell has the perfect machine for you.

## CONTENTS

### ROTARY MOWERS

<b>Rotary Mower Range Overview</b> .....	<b>4-5</b>
Topper 9 .....	<b>6-7</b>
CY2000 .....	<b>8-9</b>
SR420 .....	<b>10-11</b>
TUFFCUT 480 .....	<b>12-13</b>
TUFFCUT 650 .....	<b>14-15</b>
SR820 .....	<b>16-17</b>
Flex-wing Mower Accessories .....	<b>18-19</b>

### FLAIL MOWERS

<b>Flail Mower Range Overview</b> .....	<b>20-21</b>
Magnum .....	<b>22-23</b>
Magnum Elite .....	<b>24-25</b>
Magnum Euro .....	<b>26-27</b>
Magnum Euro Open .....	<b>28-29</b>
Magnum Dominator .....	<b>30-31</b>
Magnum Profi Mega .....	<b>32-33</b>
Magnum Elite Offset .....	<b>34-35</b>

Why McConnell? .....	<b>36-37</b>
----------------------	--------------

Please note: due to continual product development, the information in this brochure is subject to change at any time. McConnell Limited assumes no responsibility for any inaccuracies, errors or omissions and reserves the right to change specifications without notice.

# ROTARY MOWER RANGE

With a range of machines capable of tackling diverse environments from fine-turf to dense overgrowth, McConel can offer a high-performance rotary mower capable of tackling almost any challenge. There's a comprehensive choice of models with everything from toppers to flex-wing mowers and working widths from 2.0m to 8.2m.

PEAK PERFORMANCE  
MAXIMUM VERSATILITY



**McCONNELL ROTARYMOWERS**

McConnel offers a diverse range of specialist mowers from economical pasture toppers to ultra-heavy-duty vegetation clearance machines - so whether you're working in a fine-turf environment or cutting back pasture McConnel has a machine for you.



**TOPPER 9**  
WORKING WIDTH 2.75M

PAGE 6



**CY2000**  
WORKING WIDTH 2.00M

PAGE 8

**McCONNELL SR SERIES**

Fast, versatile and highly productive with working widths up to 8.2m, the SR series delivers a clean cut and an even spread of materials producing a fine finish and thriving in a wide range of applications including: airports, pasture, parks and stubble.



**SR420**  
WORKING WIDTH 4.20M

PAGE 10



**TUFFCUT 480**  
WORKING WIDTH 4.60M

PAGE 12



**TUFFCUT 650**  
WORKING WIDTH 6.28M

PAGE 14



**SR820**  
WORKING WIDTH 8.06M

PAGE 16



ROTARY MOWER

# TOPPER 9

TOPPER 9 - 2.75m (9') working width

## TOPPER 9

MODEL	TOPPER 9
<b>Specification</b>	
Working width	2.75m (9')
Cutting height	25mm-300mm
Cutting capacity	50mm
<b>Tractor requirement &amp; attachment</b>	
HP requirement	50hp
Method of attachment	3-point linkage
<b>Dimensions</b>	
Weight	950kg
Overall width	3.0m
<b>Equipment details</b>	
PTO speed	540rpm
Protection	Shear bolt
Blade carriers	2
Number of rotors	2
Blade overlap	85mm
Blade tip speed	4140m/min
Wheels	2



# CLASSIC BEST-SELLER

The UK's best-selling nine-foot topper, this heavy-duty machine has a proven track record for reliability and performance and excels as both a productive pasture and set-aside mower.

Precision-engineered in the UK, the Topper 9 is rugged and robust and built to withstand the heavy workloads of farmers, contractors and local government teams.

## KEY FEATURES

Its 2.75m working width, powerful rotors and hardened updraft swinging blades deliver on productivity, while 360-degree swivel wheels ensure the machine glides over the ground and is easy to manoeuvre in confined spaces.

- 2.75m working width
- Three-point linkage
- 540rpm PTO speed
- All-shaft drive
- Heavy-duty build quality
- Slip clutch protection
- Front and rear chain guards
- 25-300mm cutting heights
- 50mm cutting capacity
- Powerful rotor
- Replaceable full-length skids





ROTARY MOWER  
**CY2000**

CY2000 - 2.00m (6'7") working width

## CY2000

MODEL	CY2000
<b>Specification</b>	
Working width	2.00m (6'7")
Cutting height	25mm-225mm
Cutting capacity	75mm
<b>Tractor requirement &amp; attachment</b>	
HP requirement	100
Method of attachment	3-point linkage
<b>Dimensions</b>	
Weight	1400kg
Overall width	2.1m
<b>Equipment details</b>	
PTO speed	1,000rpm
Protection	Slip clutch
Number of blades	3
Number of rotors	1
Blade tip speed	4950m/min



# HEAVY-DUTY MULCHING

The strongest, toughest, most destructive mower in the McConnel arsenal. Weighing in at 1400kg, the CY2000 is the perfect machine for overgrowth clearance, making light work of saplings, stumps and scrub.

An incredibly durable machine with a robust steel deck, the CY2000 features a heavy-duty steel push bar that flattens vegetation and channels it into the path of its 7kg 'axe'-style blades. The drive is taken through a massive bevel gearbox continuous rated at 150hp with a four plate slip clutch for shock protection.



## KEY FEATURES

Capable of tackling vegetation up to 75mm in thickness, the machine's 2.0m working width and powerful cutting action ensures outstanding productivity in the toughest conditions and makes it ideal for farmers, contractors, forestry teams and local government.

- 2.0m working widths
- Three-point linkage
- 1,000rpm PTO speed
- Three 7kg axe-style cutting blades
- Four-plate slip clutch protection
- Steel push-bar
- Front and rear chain guards
- 25-225mm cutting heights
- Floating linkage for a close cut
- 75mm cutting capacity
- Powerful rotor

McCOWEL **SRSERIES**



ROTARY MOWER  
**SR420**

SR420 - 4.45m (14'7") working width

## SR SERIES

MODEL	SR420
<b>Specification</b>	
Working width	4.45m (14' 7")
Cutting height	25mm-400mm (1" - 1' 4")
Cutting capacity	100mm (4")
<b>Tractor requirement &amp; attachment</b>	
HP requirement	80hp (60kW)
Method of attachment	3-point linkage
<b>Dimensions</b>	
Machine Weight	1875kg (4134lbs)
Overall width	4.71m (15' 6")
Overall length	3.62m (11' 11")
Transport width	2.90m (9' 6")
Transport height	2.00m (6' 6")
Deck height*	0.73m (2' 5")
<b>Equipment details</b>	
PTO speed	1,000rpm
Protection	Slip clutch
Number of rotors	3
Number of blades	9 blades. Each 10mm (3/8") 30 Carbon Boron hardened and tempered.
Blade Bolts	M24 C/W shank grade 8.8
Blade overlap	110mm
Blade tip speed	75m/s = 4500 m/min
Hydraulic wing flex	45° up, 12° down
Anti-scalp dish	5mm (3/16") round pan with blade holder bar
Input shaft	1-3/8" 26 input shaft
Deck construction	All welded construction
Deck material thickness	4mm (3/16")
Skid construction	Replaceable bolt on skid shoes
Side skirt material thickness	6mm (1/4")
Driveline	ASAE Category 5
Gearbox [splitter]	Splitter - Cast Iron housing
Gearbox [rotor]	Rotor x 3 - Cast Iron housing
Gearbox oil capacity [splitter gearbox]	4.3 litres (7.6 pints)
Gearbox oil capacity [centre gearbox]	n/a
Gearbox oil capacity [rotor gearboxes]	TBC
Wheels	4 wheels - 5.00-8 rubber tyre with steel hub
Tailwheel mount assembly	Welded box section arm and caster fork with 360 degree swivel
Front guard	Single, two-piece chain guard
Rear guard	Single chain guard

\* Underside of deck to skid

# HIGH-PERFORMANCE FLEX-WING TECHNOLOGY

The SR420 is 3-point linkage mounted and features anti-scalp discs, a floating linkage system, deck protection rings and a wider choice of cutting heights.

Designed for productivity with three high-performance rotors and six cutting blades, the SR420's hardened updraft swinging blades ensure an effective cutting capacity of up to 100mm, while hydraulically folding wings enable a fast and smooth transition from transport to working position.

## KEY FEATURES

Ideal for large-scale farmers, local government teams, and professional mowing contractors, SR series machines can be used in a huge variety of applications from airports and sports venues to pasture and stubble.

- 4.45m working widths
- Floating linkage system
- 57 degrees of wing movement (+45° up, -12° down)
- Heavy-duty gearboxes
- 1,000rpm wide angle PTO
- Slip clutch protection
- Front and rear chain guards
- Hardened updraft swinging blades
- Cutting heights from 25mm to 400mm
- 100mm cutting capacity
- Nine blades
- Overlapping blades
- Low tractor hp requirement (80hp)



**TUFFCUT 480**

**NEW**



ROTARY MOWER

**TUFFCUT 480**

TUFFCUT 480 - 4.60m (15' 1") working width

## ROTARY MOWERS

MODEL	TUFFCUT 480
<b>Specification</b>	
Working width	4.60m (15' 1")
Cutting height	25mm-400mm (1" - 1' 4")
Cutting capacity	100mm (4")
<b>Tractor requirement &amp; attachment</b>	
HP requirement	70hp
Method of attachment	Drawbar
<b>Dimensions</b>	
Machine Weight	2440kg (5379lbs)
Overall width	4.79m (15' 9")
Overall length	4.91m (16' 1")
Transport width	2.70m (8' 10")
Transport height	2.17m (7' 2")
Deck height*	0.23m (9")
<b>Equipment details</b>	
PTO speed	1,000rpm
Protection	Slip clutch
Number of rotors	3
Number of blades	9, 12 or 18 blades. Each 12mm (1/2") 30 Carbon Boron hardened and tempered. Free swinging high lift – low friction
Blade Bolts	M24 C/W shank grade 8.8
Blade overlap	110mm
Blade tip speed	80mps (15748fpm)
Hydraulic wing flex	45° up, 15° down
Anti-scalp dish	6mm (1/4") round pan with blade holder bar
Input shaft	1-3/8" Z21 or Z6 SFT 6/8 tractor end
Deck construction	All welded construction
Deck material thickness	6mm (1/4")
Skid construction	Replaceable bolt on skid shoes
Side skirt material thickness	5mm (3/16")
Driveline	ASAE category 6
Gearbox [splitter]	Splitter - Cast Iron housing
Gearbox [rotor]	Rotor x 3 - Cast Iron housing
Gearbox oil capacity [splitter gearbox]	EP80-90W - 2.7 litres (4.7 pints)
Gearbox oil capacity [centre gearbox]	n/a
Gearbox oil capacity [rotor gearboxes]	85W - 140 Oil - 4.3 litres (7.6 pints)
Wheels	8 wheels
Tailwheel mount assembly	Tubular welded axle
Front guard	Single chain guards on each deck
Rear guard	Single chain guards on each deck

\* Underside of deck to skid

# FAST, FLEXIBLE, FEATURE-PACKED

The new Tuffcut 480 offers 4.6m cutting width, greater wing flexibility – with a movement range of 60 degrees – and the option of walking axles for a smoother ride over the ground.

A streamlined flat deck design makes the machine easy to clean as less debris from mowing is retained on the deck. Designed for productivity with three high-performance rotors and a choice of nine, twelve or eighteen hardened updraft swinging blades, the Tuffcut 480 can tackle material up to 100mm thick and delivers an exceptionally clean cut with an even spread of material.

## KEY FEATURES

Ideal for large-scale farmers, local government teams, and professional mowing contractors, SR series machines can be used in a huge variety of applications from airports and sports venues to pasture and stubble.

- 4.6m working widths
- High and low hitch options
- Bondioli & Pavesi gearboxes and drivelines
- 60 degrees of wing movement (+45° up, -15° down)
- 1000rpm wide angle PTO
- Slip clutch protection
- Front and rear chain guards
- Cutting heights from 25mm to 400mm
- 100mm cutting capacity
- 9, 12 or 18 blades
- Overlapping blades
- Low tractor hp requirement (70hp)
- Fixed or walking axles



**TUFFCUT 650**

**NEW**



ROTARY MOWER

**TUFFCUT 650**

TUFFCUT 650 - 6.28m (20'7") working width

## ROTARY MOWERS

MODEL	TUFFCUT 650
<b>Specification</b>	
Working width	6.28m (20' 7")
Cutting height	25mm-210mm (1" – 8 1/4")
Cutting capacity	100mm (4")
<b>Tractor requirement &amp; attachment</b>	
HP requirement	90hp
Method of attachment	Multi-position drawbar
<b>Dimensions</b>	
Machine Weight	3100kg (6834lbs)
Overall width	6.47m (21' 3")
Overall length	5.07m (16' 8")
Transport width	2.70m (8' 10")
Transport height	2.90m (9' 7")
Deck height*	0.23m (9")
<b>Equipment details</b>	
PTO speed	1,000rpm
Protection	Slip clutch
Number of rotors	5
Number of blades	15, 20 or 30 blades. Each 12mm (1/2") 30 Carbon Boron hardened and tempered. Free swinging high lift – low friction
Blade Bolts	M24 C/W shank grade 8.8
Blade overlap	110mm
Blade tip speed	79mps (15551fpm)
Hydraulic wing flex	45° up, 15° down
Anti-scalp dish	6mm (1/4") round pan with blade holder bar
Input shaft	1-3/8" Z21 or Z6 SFT 6/8 tractor end
Deck construction	All welded construction
Deck material thickness	6mm (1/4")
Skid construction	Replaceable bolt on skid shoes
Side skirt material thickness	5mm (3/16")
Driveline	ASAE category 6
Gearbox [splitter]	Splitter - Cast Iron housing
Gearbox [rotor]	Rotor x 5 - Cast Iron housing
Gearbox oil capacity [splitter gearbox]	EP80-90W - 2.7 litres (4.7 pints)
Gearbox oil capacity [centre gearbox]	n/a
Gearbox oil capacity [rotor gearboxes]	85W - 140 Oil - 1.3 litres ( 2.3 pints)
Wheels	8 wheels
Tailwheel mount assembly	Tubular welded walking axles
Front guard	Single chain guards on each deck
Rear guard	Single chain guards on each deck

\* Underside of deck to skid

# OUTSTANDING PRODUCTIVITY

McConnel's high-performance Tuffcut 650 features a 6.28m cutting width, five powerful rotors and a choice of fifteen, twenty or thirty hardened updraft swinging blades for outstanding productivity.

A streamlined flat deck design makes the machine easy to clean as less debris from mowing is retained on the deck. Capable of tackling everything from grass to gorse, the Tuffcut 650 can cut material up to 100mm thick, and has a fast-cutting action for outstanding productivity. 60 degrees of wing movement ensure the Tuffcut 650 closely follows the contours of the ground and delivers an attractive cut with an even spread, while walking axles deliver a smoother ride.

## KEY FEATURES

Ideal for large-scale farmers, local government teams, and professional mowing contractors, SR series machines can be used in a huge variety of applications from airports and sports venues to pasture and stubble.

- 6.28m working width
- High and low hitch options
- 60 degrees of wing movement (+45° up, -15° down)
- Bondioli & Pavesi gearboxes and drivelines
- Five powerful rotors
- 1,000rpm wide angle PTO
- Slip Clutch Protection
- Front and rear chain guards
- Hardened updraft swinging blades
- Cutting heights from 25mm to 210mm
- 100mm cutting capacity
- Choice of 15, 20 or 30 blades
- Walking axles



McCORMICK **SR SERIES**



ROTARY MOWER  
**SR820**

SR820 - 8.06m (26'5") working width

## SR SERIES

MODEL	SR820
<b>Specification</b>	
Working width	8.06m (26' 5")
Cutting height	25mm-210mm (1" – 8 1/4")
Cutting capacity	100mm (4")
<b>Tractor requirement &amp; attachment</b>	
HP requirement	150hp
Method of attachment	Drawbar
<b>Dimensions</b>	
Machine Weight	4330kg (9546lbs)
Overall width	8.26m (27' 1")
Overall length	6.33m (20' 9")
Transport width	2.81m (9' 3")
Transport height	6.07m (19' 11")
Deck height*	0.24m (10")
<b>Equipment details</b>	
PTO speed	1,000rpm
Protection	Slip clutch
Number of rotors	5
Number of blades	10, 20 or 30 blades. Each 12mm (1/2") 30 Carbon Boron hardened and tempered. Free swinging high lift – low friction
Blade Bolts	M24 C/W shank grade 8.8
Blade overlap	110mm
Blade tip speed	79mps (15551fpm)
Hydraulic wing flex	45° up, 15° down
Anti-scalp dish	6mm (1/4") round pan with blade holder bar
Input shaft	1-3/4 Z20 SFT 10 tractor end
Deck construction	All welded construction
Deck material thickness	5mm (3/16)
Skid construction	Replaceable bolt on skid shoes
Side skirt material thickness	6mm (4/16)
Driveline	ASAE category 4
Gearbox [splitter]	Splitter - Cast Iron housing
Gearbox [rotor]	Rotor x 5 - Cast Iron housing
Gearbox oil capacity [splitter gearbox]	EP80-90W - 2.7 litres (4.7 pints)
Gearbox oil capacity [centre gearbox]	3.5 litres (6.2 pints)
Gearbox oil capacity [rotor gearboxes]	EP80-90W - 2.1 litres (3.7 pints)
Wheels	8 wheels - 7.00 – 12 pneumatic tyre with steel hub
Tailwheel mount assembly	Tubular welded walking axles
Front guard	Single chain guards on each deck
Rear guard	Single chain guards on each deck

\* Underside of deck to skid

# THE BIGGEST AND THE BEST

McConnel's largest and most productive mower, the SR820's fast cutting action and 8.06m working width makes it one of the most productive mainstream rotary mowers on the market.

The SR820 is designed for productivity with five high-performance rotors and a choice of 10, 20 or 30 hardened updraft swinging blades that enable it to tackle material up to 100mm thick. Reliability is enhanced by a six gearbox driveline, each with built-in slip clutch protection, ensuring the power is spread evenly across the cutting width. This feature also enables an even cut and spread and an attractive finish.

## KEY FEATURES

Ideal for large-scale farmers, local government teams, and professional mowing contractors, the SR820 can be used in a huge variety of applications from airports and sports venues to pasture and stubble.

- 8.06m working width
- High and low hitch options
- 60 degrees of wing movement (+45° up, -15° down)
- Bondioli & Pavesi gearboxes and drivelines
- Five powerful rotors
- 1,000rpm wide angle PTO
- Slip Clutch Protection
- Front and rear chain guards
- Cutting heights from 25mm to 210mm
- 100mm cutting capacity
- Choice of 10, 20 or 30 blades
- Walking axles



# FLEX-WING MOWER ACCESSORIES

McConnel offers a range of performance-enhancing accessories to help you make the most of your SR Series machine.

**2 BLADES**  
per rotor

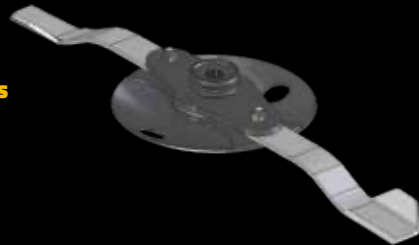

**3 BLADES**  
per rotor



**4 BLADES** per rotor

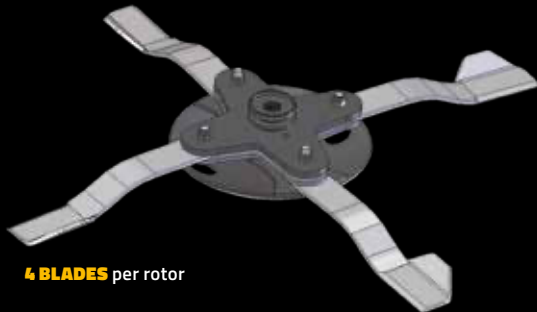

## BLADE CONFIGURATIONS

McConnel's SR range of rotary mowers comes with a choice of four different blade configurations, enabling customers to spec their machine to suit specific tasks, such as mowing and crop mulching.

All configurations use free-swinging updraft blades that lift the crop as they cut, ensuring no material is left uncut. McConnel blades are made from hardened steel and have a long and successful pedigree for toughness and durability.



**SHREDDING KIT**  
**6 BLADES** per rotor

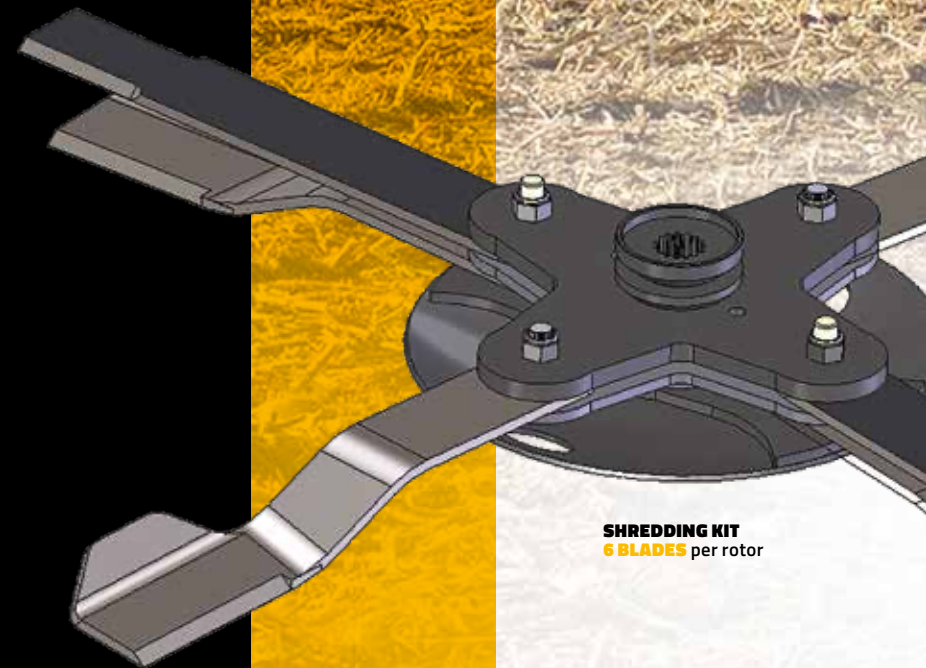

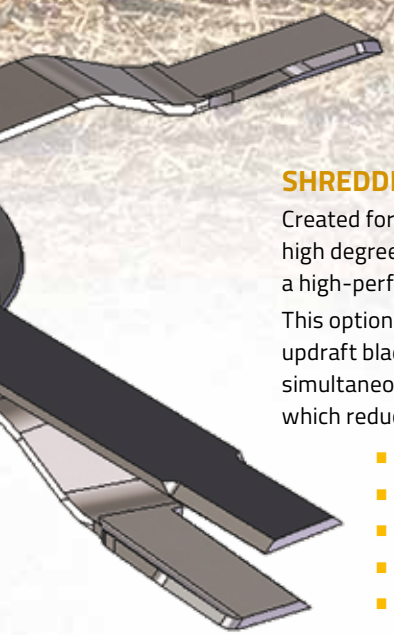

### SHREDDING KITS

Created for applications which require a high degree of mulching, McConnell offers a high-performance six-blade shredder kit. This optional upgrade consists of four updraft blades that lift and cut the material simultaneously, and two shredder blades which reduce the vegetation to a fine mulch.

- Six blades per rotor
- Heavy-duty free-swinging blades
- Robust construction
- Improved mulching
- Available on the SR460, SR620 and SR820

### WALKING AXLE KITS

Each pair of wheels has been designed to pivot around the axles so even when the surface is uneven the mower still travels smoothly.

- Individually pivoting axles
- 8-wheel configuration
- Improves travel on uneven surfaces
- Ensures an even finish
- Improves road transport
- Prevents damage to the mower

Top right: Standard axle configuration  
Right: Walking axle option



## CUTTING-EDGE MOWING TECHNOLOGY

### HITCH OPTIONS

McConnell's SR machines are available with low or high hitch options for universal compatibility.



Above: High hitch configuration  
Right: Low hitch configuration with optional Scharmuller ball hitch



# FLAIL MOWER RANGE

McConel offers a choice of flail mowers from compact models with 1.3m and 1.5m working widths to powerful heavy-duty mowers that offer the best in durability, productivity and performance. Six different series and 21 distinct models are currently available ensuring that whatever the task, McConel has a machine perfectly suited to meet your needs.

ROBUST BUILD  
PERFECT FINISH





## IN-LINE FLAIL MOWERS

Proven in the field all over the world, McConnell's Magnum range of In-Line Flail Mowers is strong and versatile and delivers an exceptional mulching performance and an attractive finish.



**MAGNUM**  
WORKING WIDTH 1.30 - 1.50M

PAGE 22



**MAGNUM ELITE**  
WORKING WIDTH 1.90 - 2.70M

PAGE 24



**MAGNUM EURO**  
WORKING WIDTH 2.30 - 2.80M

PAGE 26



**MAGNUM EURO OPEN**  
WORKING WIDTH 2.28 - 2.77M

PAGE 28



**MAGNUM DOMINATOR**  
WORKING WIDTH 2.50 - 3.10M

PAGE 30



**MAGNUM PROFI MEGA**  
WORKING WIDTH 2.50 - 3.00M

PAGE 32



## OFFSET FLAIL MOWER

McConnell's Magnum Elite Offset Flail Mower has an innovative Z-link design and is ideal for cost effective verge mowing and even capable of trimming the sides of hedges.



**MAGNUM ELITE OFFSET**  
WORKING WIDTH 1.62 - 2.27M

PAGE 34

## MAGNUM

### TYPE

Manual  
Offset

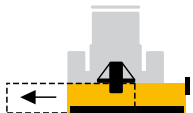

### MOUNTING

Rear

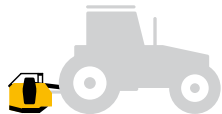

### REAR GATE

Fixed



FLAIL MOWER

# MAGNUM

**MAGNUM 130** - 1.30m (4'3") working width  
**MAGNUM 150** - 1.50m (4'11") working width

## MAGNUM SERIES

MODEL	MAGNUM 130	MAGNUM 150
<b>Specification</b>		
Working width	1.30m (4'3")	1.50m (4'11")
Cutting height	16mm-56mm	16mm-56mm
Cutting capacity	30mm	30mm
<b>Tractor requirement &amp; attachment</b>		
HP requirement	35hp	40hp
Method of attachment	3-point linkage	3-point linkage
<b>Dimensions</b>		
Weight	213kg	237kg
Overall width	1.4m	1.6m
<b>Equipment details</b>		
PTO speed	540rpm	540rpm
Protection	Slip clutch	Slip clutch
Number of flails	18	20
Manual offset	154mm	154mm
Number of rotors	1	1
Roller diameter	140mm	140mm



# COMPACT MOWER, BIG PERFORMANCE

Compact and lightweight, McConnell's productive Magnum series flail mowers have a low power requirement and are ideal for customers with compact tractors.

Created for the amenities and ground-care sectors, the Magnum series features a choice of 1.3m and 1.5m working widths and offers excellent manoeuvrability and value.

## KEY FEATURES

Capable of cutting material up to 30mm thick, the machines are armed with durable whale-tail flails and can tackle everything from grass and crop residues to thick vegetation.

- 1.3m and 1.5m working widths
- Three-point linkage (CAT I)
- 540rpm PTO speed
- 30mm cutting capacity
- 16-56mm cutting height
- Slip clutch protection
- 154mm manual offset
- Rear roller height adjustment



## MAGNUM ELITE

### TYPE

Hydraulic  
Side Shift



### MOUNTING

Rear

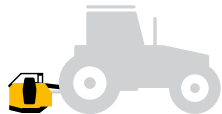

### REAR GATE

Fixed



FLAIL MOWER

# MAGNUM ELITE

**MAGNUM ELITE 190** - 1.90m (6'3") working width  
**MAGNUM ELITE 225** - 2.27m (7'5") working width  
**MAGNUM ELITE 245** - 2.42m (7'11") working width  
**MAGNUM ELITE 270** - 2.70m (8'10") working width

## MAGNUM ELITE SERIES

MODEL	MAGNUM ELITE 190	MAGNUM ELITE 225	MAGNUM ELITE 245	MAGNUM ELITE 270
<b>Specification</b>				
Working width	1.90m (6'3")	2.27m (7'5")	2.42m (7'11")	2.70m (8'10")
Cutting height	30mm-80mm	30mm-80mm	30mm-80mm	30mm-80mm
Cutting capacity	50mm	50mm	50mm	50mm
<b>Tractor requirement &amp; attachment</b>				
HP requirement	50	60	80	85
Method of attachment	3-point linkage	3-point linkage	3-point linkage	3-point linkage
<b>Dimensions</b>				
Weight	502kg	554kg	596kg	632kg
Overall width	2.12m	2.47m	2.62m	2.92m
<b>Equipment details</b>				
PTO speed	540rpm	540rpm	540rpm	540rpm
Protection	Slip clutch	Slip clutch	Slip clutch	Slip clutch
Number of flails	24	28	30	34
Hydraulic offset	400mm	400mm	400mm	400mm
Roller diameter	140	140	140	140



# VERSATILITY AND VALUE

A robust and productive series of flail mowers with a powerful cutting action that's ideal for tackling grass, crop residues and tree cuttings.

Created for farmers, contractors and local government, the Magnum Elite series offers four different cutting widths from 1.9m to 2.7m and can tackle material up to 50mm thick – making it an ideal tool for a wide variety of green maintenance tasks.

## KEY FEATURES

A strong main frame and reinforced three-point linkage combine with solid steel construction and over-run PTO protection to boost durability and ensure the machine can withstand a heavy workload.

- 1.9m, 2.27m, 2.42m, and 2.7m working widths
- Three-point linkage mounting
- 540rpm PTO speed (1000rpm for the 2.7m model)
- 50mm cutting capacity
- 30–80mm cutting height
- Durable design
- Whale-tail flails
- Slip clutch protection
- 400mm offset
- Replaceable full-length skids



## MAGNUM EURO

### TYPE

Hydraulic  
Side Shift

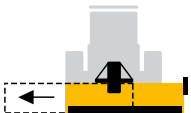

### MOUNTING

Rear or  
Front



### REAR GATE

Fixed



FLAIL MOWER

# MAGNUM EURO

**MAGNUM EURO 230** - 2.30m (7'7") working width  
**MAGNUM EURO 250** - 2.45m (8'0") working width  
**MAGNUM EURO 280** - 2.80m (9'2") working width

## MAGNUM EURO SERIES

MODEL	MAGNUM EURO 230	MAGNUM EURO 250	MAGNUM EURO 280
<b>Specification</b>			
Working width	2.30m (7'7")	2.45m (8'0")	2.80m (9'2")
Cutting height	30mm-80mm	30mm-80mm	30mm-80mm
Cutting capacity	60mm	60mm	60mm
<b>Tractor requirement &amp; attachment</b>			
HP requirement	55	65	75
Method of attachment	3-point linkage	3-point linkage	3-point linkage
<b>Dimensions</b>			
Weight	806kg	847kg	917kg
Overall width	2.51m	2.67m	3.00m
<b>Equipment details</b>			
PTO speed	540rpm	1000rpm	1000rpm
Protection	Slip clutch	Slip clutch	Slip clutch
Number of flails	26	28	32
Hydraulic offset	400mm	400mm	400mm
Roller diameter	140	140	140



# PRODUCTIVE AND POWERFUL

Tougher, stronger and more productive than the popular Magnum Elite Series, McConnell's Euro machines offer a choice of 2.3m, 2.45m, and 2.8m cutting widths and make light work of material up to 60mm thick.

Designed for tackling grass, gorse, OSR and maize stubble, the Euro series offers a cutting power and versatility that is much sought after by large-scale farmers, contractors, and local government teams.



## KEY FEATURES

Created to thrive on busy workloads, the three Euro machines boast rugged build quality, PTO over-run protection, full-length replaceable skids, and automatic belt tensioning.

- 2.3m, 2.45m, and 2.8m working widths
- Three-point linkage mounting
- Front and rear mounting
- 540rpm PTO speed (1000rpm for the 2.8m model)
- 60mm cutting capacity
- 30-80mm cutting height
- Durable design
- Whale-tail flails
- Slip clutch protection
- 400mm offset
- Adjustable rear roller
- Replaceable full-length skids

## MAGNUM EURO OPEN

### TYPE

Hydraulic  
Side Shift

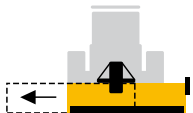

### MOUNTING

Rear

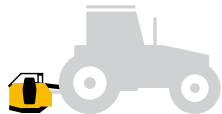

### REAR GATE

Adjustable



FLAIL MOWER

# MAGNUM EURO OPEN

**MAGNUM EURO OPEN 230**

- 2.28m (7'6") working width

**MAGNUM EURO OPEN 245**

- 2.45m (8'0") working width

**MAGNUM EURO OPEN 280**

- 2.77m (9'1") working width

## MAGNUM EURO OPEN SERIES

MODEL	MAGNUM EURO OPEN 230	MAGNUM EURO OPEN 245	MAGNUM EURO OPEN 280
<b>Specification</b>			
Working width	2.28m (7'6")	2.45m (8'0")	2.77m (9'1")
Cutting height	30mm-80mm	30mm-80mm	30mm-80mm
Cutting capacity	60mm	60mm	60mm
<b>Tractor requirement &amp; attachment</b>			
HP requirement	55	65	75
Method of attachment	3-point linkage	3-point linkage	3-point linkage
<b>Dimensions</b>			
Weight	683kg	719kg	791kg
Overall width	2.51m	2.67m	3.0m
<b>Equipment details</b>			
PTO speed	1000rpm	1000rpm	1000rpm
Protection	Slip clutch	Slip clutch	Slip clutch
Number of flails	26	28	32
Hydraulic offset	400mm	400mm	400mm
Roller diameter	168mm	168mm	168mm



# PRECISION AND PERFORMANCE

McConnel's heavy-duty Magnum Euro Open brings all the benefits of the professional-spec Euro model, but adds an adjustable rear gate that allows operators to customise the flow of material through the mower to suit a wide range of applications.

Available in three different working widths from 2.3m to 2.8m, the Euro Open range can be adjusted to deliver everything from a fine-cut finish to a heavy-duty mulch.

## KEY FEATURES

Designed for busy farmers, contractors and local government teams, the Euro series delivers power, precision and reliability while still being compatible with tractors of just 55hp and upwards.

- 2.28m, 2.45m, and 2.77m working widths
- Three-point linkage mounting
- Five-position rear gate
- 1,000rpm PTO speed
- 50mm cutting capacity
- 30-80mm cutting height
- Durable design
- Whale-tail flails
- Slip clutch protection
- 400mm hydraulic offset
- Adjustable rear roller
- Replaceable full-length steel skids



## MAGNUM DOMINATOR

### TYPE

Hydraulic  
Side Shift

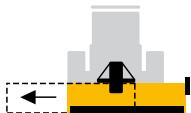

### MOUNTING

Rear or  
Front



FLAIL MOWER

# MAGNUM DOMINATOR

**MAGNUM DOMINATOR 250**

- 2.50m (8'2") working width

**MAGNUM DOMINATOR 280**

- 2.80m (9'2") working width

**MAGNUM DOMINATOR 310**

- 3.10m (10'2") working width

## MAGNUM DOMINATOR SERIES

MODEL	MAGNUM DOMINATOR 250	MAGNUM DOMINATOR 280	MAGNUM DOMINATOR 310
<b>Specification</b>			
Working width	2.50m (8'2")	2.80m (9'2")	3.10m (10'2")
Cutting height	25mm-100mm	25mm-100mm	25mm - 100mm
Cutting capacity	60mm	60mm	60mm
<b>Tractor requirement &amp;</b>			
HP requirement	65hp	75hp	90hp
Method of attachment	3-point linkage	3-point linkage	3-point linkage
<b>Dimensions</b>			
Weight	971kg	1023kg	1093Kg
Overall width	2.67m (8'9")	3.00m (9'10")	3.33m (10'11")
<b>Equipment details</b>			
PTO speed	1,000rpm	1,000rpm	1,000rpm
Protection	Overrunning clutch	Overrunning clutch	Overrunning clutch
Number of flails	28	32	36
Hydraulic offset	500mm	500mm	500mm
Roller diameter	168mm	168mm	168mm



# HEAVY-DUTY MULTI-PURPOSE

McConel's professional combi (front and rear) heavy-duty multipurpose flail mower, ideal for mulching large quantities of crop residues at high working speed and in all working conditions. Suitable for mulching material up to 6 cm in diameter on agricultural, communal or abandoned areas.

Available in three different working widths from 2.5m to 3.1m, the Dominator range can be adjusted to deliver everything from a fine-cut finish to a heavy-duty mulch.

## KEY FEATURES

Designed for large scale farmers, contractors and local government teams, the Dominator series can shred everything from dense overgrowth to maize stubble at a high working speed and deliver a fine cut finish.

- 2.5m, 2.8m, and 3.1m working widths
- Three-point linkage
- Combi, front and rear mounting
- 1,000rpm PTO speed
- Forged and hardened hammer flails
- Hydraulic Offset
- Automatic belt tension
- Height adjusted self cleaning roller
- Replacable protection side skirts
- Controlled floating position



## MAGNUM PROFI MEGA

### TYPE

Hydraulic  
Side Shift

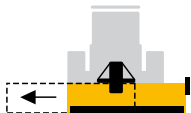

### MOUNTING

Rear or  
Front



### REAR GATE

Adjustable



FLAIL MOWER

# MAGNUM PROFI MEGA

**MAGNUM PROFI MEGA 250**  
- 2.50m (8'3") working width

**MAGNUM PROFI MEGA 270**  
- 2.70m (8'10") working width

**MAGNUM PROFI MEGA 300**  
- 3.00m (9'11") working width

## MAGNUM PROFI MEGA SERIES

MODEL	MAGNUM PROFI MEGA 250	MAGNUM PROFI MEGA 270	MAGNUM PROFI MEGA 300
<b>Specification</b>			
Working width	2.50m (8'3")	2.70m (8'10")	3.00m (9' 11")
Cutting height	45mm - 140mm	45mm - 140mm	45mm - 140mm
Cutting capacity	80mm	80mm	80mm
<b>Tractor requirement &amp; attachment</b>			
HP requirement	65	80	95
Method of attachment	3-point linkage	3-point linkage	3-point linkage
<b>Dimensions</b>			
Weight	1017kg	1265kg	1325kg
Overall width	2.7m	3.0m	3.25m
<b>Equipment details</b>			
PTO speed	1,000rpm	1,000rpm	1,00rpm
Protection	Slip clutch	Slip clutch	Slip clutch
Hydraulic Offset	400mm	400mm	400mm
Number of flails	20 or 60	24 or 72	26 or 78
Rear roller diameter	170mm	170mm	170mm



# HEAVY-DUTY MULCHER

Available in 2.5m, 2.7m and 3.0m working widths, the Magnum Profi Mega is McConnel's most powerful flail mower. It is capable of cutting through vegetation up to 80cm thick and is ideal for fast, effective mulching in gorse, dense overgrowth and thick stubble.

Featuring heavy-duty build quality throughout, the Profi Mega thrives on heavy workloads and in challenging environments making it an ideal tool for forestry specialists, full-time contractors, and local government.

## KEY FEATURES

Flexibility is key with front and rear mounting available and a fully adjustable five-position rear gate, allowing operators to spec the machine to deliver everything from a fine-cut finish to a heavy-duty mulch.

- 2.5m, 2.7m, and 3.0m working widths
- Three-point linkage mounting
- Five-position rear gate
- Double row ball-bearings on the rotor shaft
- 1,000rpm PTO speed
- 80mm cutting capacity
- Durable design
- Slip clutch protection
- 400mm hydraulic offset
- Adjustable rear roller
- Replaceable full-length steel skids



## MAGNUM ELITE OFFSET

### TYPE

Fully Offset



### MOUNTING

Rear

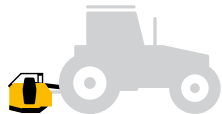

### REAR GATE

Fixed



FLAIL MOWER

# MAGNUM ELITE OFFSET

**MAGNUM ELITE OFFSET 160**

- 1.62m (5'4") working width

**MAGNUM ELITE OFFSET 190**

- 1.92m (6'4") working width

**MAGNUM ELITE OFFSET 225**

- 2.27m (7'5") working width

## MAGNUM ELITE OFFSET SERIES

MODEL	MAGNUM ELITE OFFSET 160	MAGNUM ELITE OFFSET 190	MAGNUM ELITE OFFSET 225
<b>Specification</b>			
Working width	1.62m (5'4")	1.92m (6'4")	2.27m (7'5")
Cutting height	30mm-80mm	30mm-80mm	30mm-80mm
Cutting capacity	60mm	60mm	60mm
<b>Tractor requirement &amp; attachment</b>			
HP requirement	50hp	70hp	80hp
Method of attachment	3-point linkage	3-point linkage	3-point linkage
<b>Dimensions</b>			
Weight	659kg	746kg	824kg
Overall width	1.97m	2.43m	2.78m
<b>Equipment details</b>			
PTO speed	540rpm	540rpm	540rpm
Protection	Slip clutch	Slip clutch	Slip clutch
Number of flails	20	24	28
Hydraulic adjustment range	90° up, 65° down	90° up, 65° down	90° up, 65° down



# VERSATILE OFFSET MOWING

An innovative Z-link machine which is ideal for cost-effective verge and embankment mowing, the Elite Offset is productive and versatile and is even capable of trimming the sides of hedges.

Available in three different working widths from 1.62m to 2.27m, the Magnum Elite Offset offers 155 degrees of lateral movement, and a floating linkage system that allows it to follow the contours of the ground.



## KEY FEATURES

Breakaway protection keeps the machine safe from damage on striking an obstacle, while PTO over-run protection and a double skin body ensure the best in durability.

- 1.62m, 1.92m, and 2.27m working widths
- Three-point linkage mounting
- 155 degree head movement (+90° and -65°)
- 540rpm PTO speed
- 50mm cutting capacity
- Rigid linkage
- Belt shield guard
- Durable design
- Whale-tail flails
- PTO over-run protection
- Extension up to 3.25m
- Optional hydraulic floatation system



# WHY MCCONNELL?

When you buy a McConnell rotary or flail mower, you're not just buying a high-performance machine – you're also getting a first-class aftercare package that supports you through the lifespan of your product. So whether you need an urgent part; service assistance; or online information on how to get the best from your machine, McConnell should always be your first choice.

Key benefits of buying your machine from McConnell include:

- An international network of dealers and distributors provides full service and support in 40 countries across the globe
- Every machine is subjected to an exhaustive performance test before being released to a customer
- A comprehensive stock of genuine replacement parts can be sent to dealers around the world via international couriers
- McConnell has a proud 80-year heritage and a proven track record of expertise in the design and manufacture of hedge-cutting and mowing technology
- From world's first to world's best – McConnell launched the first ever tractor mounted hedgecutter back in 1948 and has led the way as the number one in green maintenance ever since
- Our highly-skilled team of service professionals train hundreds of dealers every year and can offer expert support if you have an issue that can't be resolved quickly by your local dealer
- Customisation is fully supported with McConnell working with customers to help them create bespoke machines
- An online library of essential information including Operator's Guides, Parts Books, and multimedia product information is available 24/7

McConnel offers a proven product range, strong after-care support, and an international network of dealers and distributors spanning 40 countries, so if you're keen to take advantage of our high-performance products, **can you afford not to choose McConnel?**



## POWER ARMS

McConnel offers a comprehensive selection of Power Arms with 10 different series and 37 different models. Customers can choose from thousands of different build variations to create a personalised specification that is ideal for their needs. A wide selection of working attachments is also available from saw blades to ditch cleaners.



For more information on McConnel's full machine line-up **please visit [www.mcconnel.com](http://www.mcconnel.com)**



## REMOTE CONTROL

With four different models and a choice of 20 distinct working attachments, McConnel can offer a safe and effective remote control solution for almost any challenge. Featuring a 150m working range and an innovative low centre of gravity design, McConnel machines remove the operator from the danger zone and open up work environments that were previously hazardous, hard to reach or restricted-access.

## AGRIBUGGY

Unrivalled low ground pressure design, market-leading traction and stability and greater comfort are just a few of the key benefits delivered by McConnel's Agribuggy2 AB30 power unit. The mechanical drive technology offers best-in-class traction - delivering power and braking to all four wheels simultaneously for better grip when working in wet conditions and tough terrain, allowing safe, productive working earlier and later in the year than rivals.





**SALES**

Tel: +44 (0)1584 873131  
sales@mccommel.com

**PARTS**

Tel: +44 (0)1584 876888  
parts@mccommel.com

**SERVICE**

Tel: +44 (0)1584 875848  
service@mccommel.com

**MARKETING**

Tel: +44 (0)1584 813412  
marketing@mccommel.com



**McConnel Limited**  
Temeside Works, Ludlow,  
Shropshire SY8 1JL  
United Kingdom

Tel **+44 (0)1584 873131**  
E-mail **sales@mccommel.com**  
Website **www.mccommel.com**



**100% Recyclable**  
Responsibly  
sourced paper



FM 25970

A Member of the

